



Demo Kit Manual

AS3932

Standard Board

AS3932 DEMOBOARD

Table of Contents

- 1 Introduction 4
- 1.1 Kit Content 4
- 2 Getting Started 4
- 3 Hardware Description..... 5
- 3.1 AS3932 Receiver Board 5
- 3.2 125 kHz Wake-up Transmitter Board..... 7
- 4 Software Description 8
- 4.1 Installing the GUI..... 8
- 4.2 Description of the GUI for the AS3932 Demo Board 8
- 4.2.1 Setting Descriptions 9
- 4.2.1.1 Channel Enable..... 9
- 4.2.1.2 Low Power Mode 9
- 4.2.1.3 Clock Generator 9
- 4.2.1.4 Calibrate RC Oscillator 10
- 4.2.1.5 Antenna Damper 10
- 4.2.1.6 Envelope Detector Time Constant 10
- 4.2.1.7 Data Slicer..... 10
- 4.2.1.8 Comparator Hysteresis 10
- 4.2.1.9 Gain Reduction 10
- 4.2.1.10 Frequency Detection Tolerance..... 10
- 4.2.1.11 General Settings 10
- 4.2.1.12 Wake-up Pattern (Manchester)..... 11
- 4.2.1.13 Correlator 11
- 4.2.1.14 Automatic Time-Out 11
- 4.2.1.15 Clear Wake 11
- 4.2.1.16 Symbol Rate..... 11
- 4.2.1.17 Artificial Wake-up 11
- 4.2.1.18 Clear False Wake-up 11
- 4.2.1.19 Reset RSSI 11
- 4.3 Description of the GUI for the Wake-up Transmitter Board..... 12
- 4.3.1 Settings Description 12
- 4.3.1.1 Duration of the Carrier Burst 12
- 4.3.1.2 Number of Preamble Symbols 12
- 4.3.1.3 Symbol Rate..... 13

- 4.3.1.4 Enable Buzzer 13
- 4.3.1.5 Wake-up Pattern (Manchester) 13
- 4.3.1.6 Manchester Pattern Length 13
- 4.3.1.7 Correlator 13
- 5 Schematics, Layers and BOM 19
- 5.1 AS3932 Demo Board Schematics 13
- 5.2 AS3932 Demo Board Layout 14
- 5.3 AS3932 Demo Board BOM 15
- 5.4 125 kHz Wake-up Transmitter Board Schematic 16
- 5.5 125 kHz Wake-up Transmitter Board Layout 16
- 5.6 125 kHz Wake-up Transmitter Board BOM 17
- 6 Ordering & Contact Information 18
- 7 Copyrights & Disclaimer 19
- 8 Revision Information 20

1 Introduction

The AS3932 Demo Board demonstrates the main features of the AS3932. These include 3D wake-up pattern detection, readout of false wake-ups, possibility to measure current consumption in different operating modes, and measurement access to SPI communication and data output. Additional features are accessible via USB through the GUI that was developed for easy access to the register map. Features such as the programmable wake-up pattern, adjustable sensitivity level, low power listening modes and several more can be programmed via the GUI. The influence different settings have on the detection efficiency can be observed right away by using the 125 kHz Wake-up Transmitter Board.

1.1 Kit Content

The AS3932 Demo Kit contains the following items:

- 1x AS3932 Demo Board
- 1x 125kHz Wake-up Transmitter Board
- 1x 9V power supply
- 2x CR2032 Coin Cell
- 1x USB stick
- 1x USB Cable

2 Getting Started

- Connect the +9V DC Power Supply at “**F**” on the 125 kHz Wake-up Transmitter Board.
- Start to transmit Wake-up Patterns via AUTO “**C**” or PATTERN “**B**”.
- Insert the +3V Battery at “**H**” of the AS3932 Demo Board.
- Turn on the AS3932 Demo Board via the ON/OFF – switch “**C**”. When turning on the boards all indication-LEDs flash up once.
- As soon as the AS3932 Demo Board receives a Wake-up Pattern, the RSSI LEDs flash up for 0.5s and show the actual Received Signal Strength. At the same time the X, the Y, or the Z LED flashes up and indicates which channel got the strongest signal.

3 Hardware Description

3.1 AS3932 Receiver Board

Figure 1: Demo Board Description

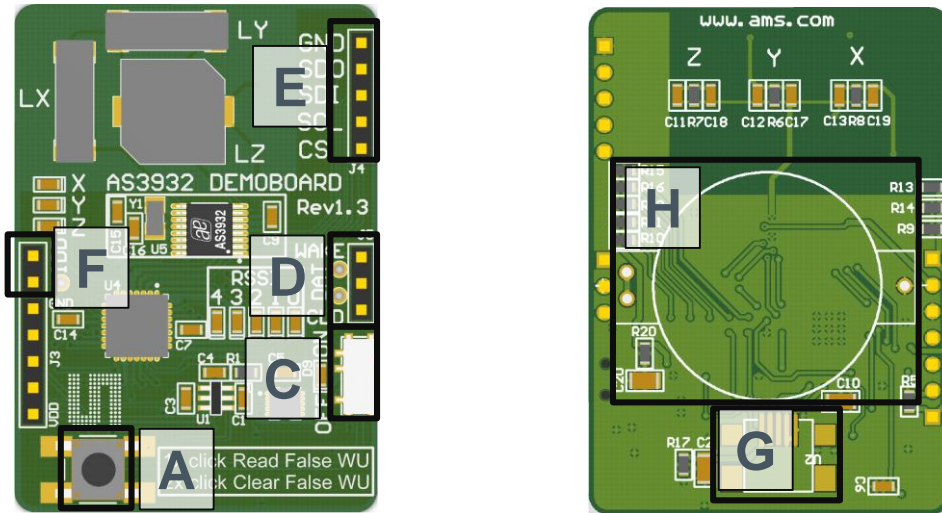

Figure 2: Mechanical Elements

Label	Name	Description	Info
A	BUTTON	1x short press reads the false wake-ups	The number of false wake-ups can be read out and are displayed via the RSSI-LEDs
A	BUTTON	2x short press (double-click) clears false wake-ups	Pressing the button twice in quick succession resets the number of false wake-ups. Each RSSI-LED lights up shortly.
C	ON/OFF	ON/OFF – Switch	Power on/off the demo board. The power source (battery or USB) is automatically detected.
G	USB-Connector	Mini USB 5-pin Connector	USB interface for the GUI
H	CR2032	Battery Holder	Insert CR2032 coin cell here

Figure 3: Indication LEDs

LEDs	Blinking Colour	Info
------	-----------------	------

LEDs	Blinking Colour	Info
RSSI (5 bits)	Red LEDs	Received Signal Strength Indication. Displays the received signal strength whenever a wake-up occurs. When pressing the False Wake-up button these LEDs display the number of false wake-ups that have occurred since the False Wake-up register was last reset.
X	Red LED	Strongest wake-up signal received on channel 1 (X)
Y	Red LED	Strongest wake-up signal received on channel 2 (Y)
Z	Red LED	Strongest wake-up signal received on channel 3 (Z)

Figure 4: Jumper Description

Jumper	Name	Description	Info
F	IDD	Supply Current	The supply current of the AS3932 can be measured. Set this jumper for normal operation.
D		AS3932 specific outputs	
	D1	WAKE	Wake output interrupt
	D2	DAT	Data output
	D3	CL_DAT	Manchester recovered clock
E		Microcontroller Interface	The SDI interface from the microcontroller can be replaced by a proprietary solution
	E1	CS	Serial digital interface chip select
	E2	SCL	Serial digital interface clock
	E3	SDI	Serial digital interface input
	E4	SDO	Serial digital interface output
	E5	GND	Ground (0V)

Note: Before connecting the AS3932 to the GUI it is necessary to RESET the device. This can be done by turning the board OFF and ON via switch "C" or by pressing buttons "A" and "B" at the same time before connecting the USB cable.

3.2 125 kHz Wake-up Transmitter Board

Figure 5: Transceiver Board Description

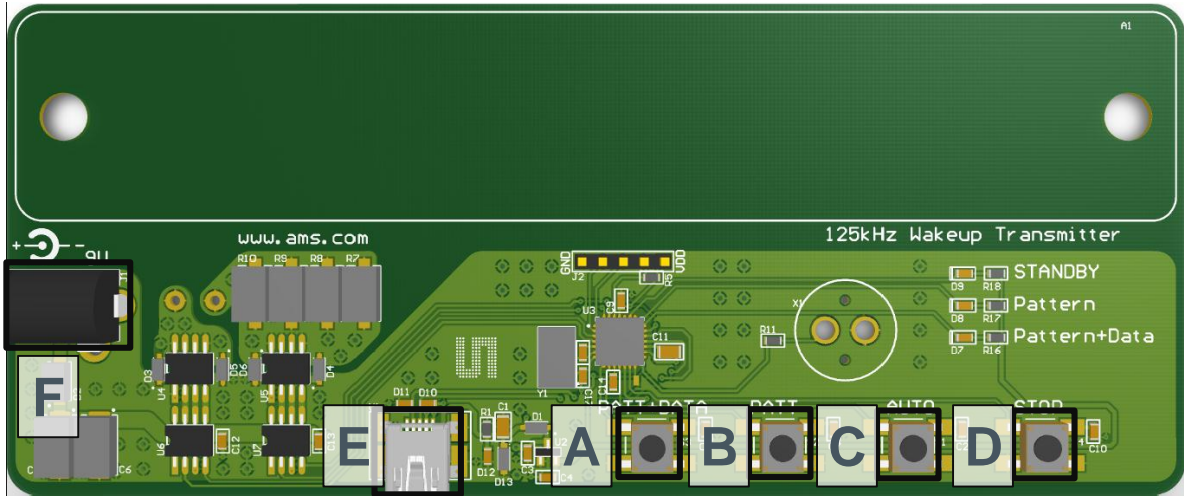

Figure 6: User Interface Description

Label	Name	Description	Info
A	PATT+DATA	Pattern+Data – Button	Pressing this button the transmitter sends continuously the wake-up pattern plus data (01010101).
B	PATT	Single Pattern – Button	Pressing this button the transmitter sends a single wake-up pattern.
C	AUTO	Automatic Pattern – Button	Pressing this button the transmitter automatically sends a wake-up pattern every 1s
D	STOP	Stop Pattern – Button	This button stops sending the continuous wake-up pattern
E	USB-Connector	Mini USB 5-pin Connector	USB Interface for the GUI
F	Power Supply	+9V DC Power Supply (2A)	Insert power adapter here.

Figure 7: Indication LEDs/Buzzer

LEDs	Blinking Color	Info
G	Buzzer	Whenever a wake-up pattern is transmitted the buzzer signals shortly. The buzzer can be disabled via the GUI.
STANDBY	Red LED	Transmitter is on standby. No wake-up pattern is sent.
Pattern	Red LED	Wake-up pattern is transmitted
Pattern+Data	Red LED	Wake-up pattern plus data is transmitted

Note: Before the 125 kHz Wake-up Transmitter is connected to the GUI via USB it is necessary to stop transmitting Wake-up Patterns by pressing the button “D”.

4 Software Description

4.1 Installing the GUI

- Execute the AS393x_EvalSW_v2.1.6b.msi which can be found on the USB stick in the folder ‘Software_Firmware’
- Follow the installation guide
- Run the GUI → AS393x_EvalSW.exe
- Attach the respective board (Demo Board or Transmitter Board) with the USB cable
- From the pop up window ‘Choose Plugin’ choose the ‘AS3932_plugin.dll’

Note: Before connecting the 125 kHz Wake-up Transmitter Board with the USB cable press “D” to stop transmitting wake-up patterns.

4.2 Description of the GUI for the AS3932 Demo Board

The settings shown in the GUI correspond to the respective settings in the register map. Changing any setting via the GUI writes the according values to the AS3932’s registers. The register map can be viewed via View/Register Map (Ctrl+M). All registers can be updated manually via File/Readout Registers (Ctrl+R) or the update of the registers is done automatically via File/Automatic Update (Ctrl+U). It is also possible to write to the register map by directly clicking on the bits in the ‘Register Map’ window. This is possible for all white fields. Grey fields are read only.

All adjustments that are made to the settings can be saved via “**Store Settings**” in the lower right corner of the ‘Receiver’ tab. The settings can be reset to the default configuration by pushing the button ‘**Preset Default**’.

Note: A possible firmware update can be done via Help/Firmware Update (Ctrl+F). Load the latest *.bin file for the receiver and update the firmware.

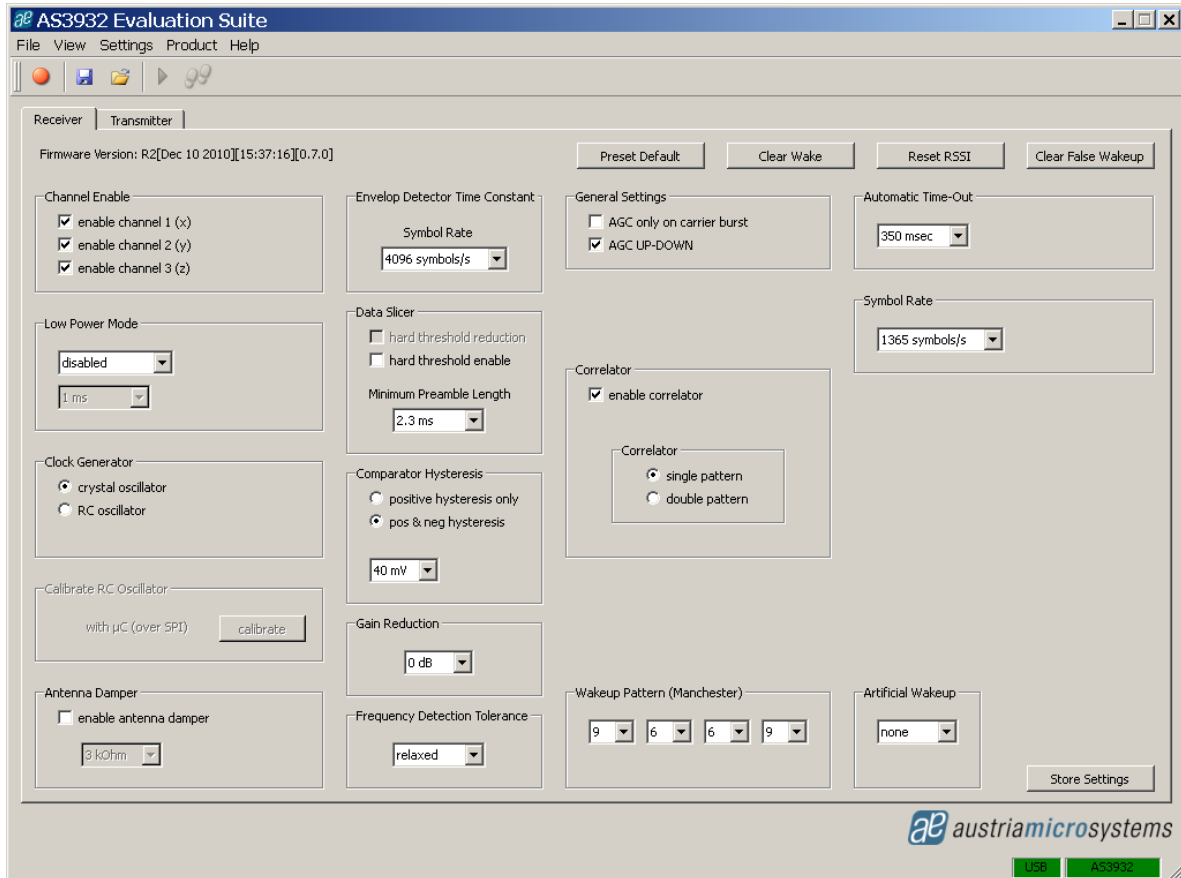
Figure 8: Graphical User Interface (GUI) for the AS3932 Demo Board

4.2.1 Setting Descriptions

4.2.1.1 Channel Enable

The AS3932 Demo Board has a three dimensional antenna. In the 'Channel Enable' field each of these three antenna inputs can be enabled or disabled.

4.2.1.2 Low Power Mode

The AS3932 features two low power modes: scanning mode and on/off mode. These can be selected here. By default no power saving mode is enabled. This means that the selected channels are active all the time. The other modes save power by regularly switching the channels on and off (on/off mode), or by having only one channel active at one time (scanning mode). Further details are given in the AS3932 datasheet.

4.2.1.3 Clock Generator

The clock source for the AS3932 can be selected here. The AS3932 Demo Board features an on board crystal oscillator which is used by default. In addition the AS3932 internal RC oscillator can be enabled.

4.2.1.4 Calibrate RC Oscillator

When the RC oscillator is enabled it can be calibrated to achieve better receiver sensitivity. The oscillator is calibrated via the microcontroller.

4.2.1.5 Antenna Damper

In case the signal levels at the input of the AS3932 are too high or the surrounding noise level is high the antenna damper can be enabled. A resistor inside the AS3932 is then switched parallel to the antenna. The value of the resistor can be selected between 1k Ω to 27k Ω to achieve different quality factors of the antenna tank.

4.2.1.6 Envelope Detector Time Constant

The performance of the demodulator can be optimized according to the bit rate and preamble length. If the bit rate gets higher the time constant needs to get lower. Adjust this ED time constant according to your symbol rate. The recommended time constants for different symbol rates are listed in the datasheet.

4.2.1.7 Data Slicer

The threshold of the data slicer can be set to a fixed level by setting the 'hard threshold enable' bit. This hard threshold can be reduced by setting the 'hard threshold reduction' bit. Otherwise, the threshold will be dynamically set according to the incoming data signal.

In case the dynamic threshold is used (i.e. the 'hard threshold enable' bit is not set), the data slicer's noise immunity can be adjusted via the data slicer's time constant. The bigger this time constant is, the better its noise immunity will be. However, increasing the time constant is only effective if also the preamble length is increased. Otherwise, the threshold will not have enough time to settle to the correct value. Therefore, the data slicer's time constant is linked to the minimum preamble length. The recommended minimum preamble lengths for different data slicer time constants are listed in the datasheet.

4.2.1.8 Comparator Hysteresis

The comparator hysteresis of the data slicer can be adjusted between 20mV and 40mV. Furthermore, the data slicer hysteresis can be either selected only for positive edges or for both positive and negative edges.

4.2.1.9 Gain Reduction

The gain reduction of the channel amplifier can be selected between 0dB up to -24dB.

4.2.1.10 Frequency Detection Tolerance

The frequency detection tolerance can be tighter or more relaxed. For details please see the datasheet.

4.2.1.11 General Settings

- AGC only on carrier burst: The automatic gain control is acting only on the first carrier burst.
- AGC UP-DOWN: The automatic gain control is operating in both directions (up and down).

The channel amplifier always starts with the highest gain setting at the beginning of reception. As soon as a signal is detected, the AGC starts reducing the gain to achieve the optimum signal amplification. If AGC UP-DOWN is disabled the AGC can only decrease the gain for the duration of data reception. In this mode the system holds the RSSI peak.

4.2.1.12 Wake-up Pattern (Manchester)

Select the desired wake-up pattern here. Each field defines 4 bit. If the pattern that is transmitted by the Wake-up Pattern Transmitter matches the selected pattern of the AS3932 Demo Board, a wake-up interrupt is generated at the WAKE pin. The WAKE pin goes high.

4.2.1.13 Correlator

The Correlator needs to be enabled to configure the AS3932 to wake up upon pattern detection. Otherwise, if it is disabled, the AS3932 will wake up after detecting the carrier burst. In case it is enabled, after the carrier burst it searches for the preamble bits and then for data pattern (Manchester encoded wake-up pattern). Should the pattern correlation be disabled, the AS3932 goes directly in data receiving mode after the carrier burst.

Single pattern: The wake-up pattern is 16 bits long.

Double pattern: The single pattern is sent twice in a row.

4.2.1.14 Automatic Time-Out

The Automatic Time-Out resets the WAKE pin automatically after a certain time. The AS3932 then goes back into listening mode. This time can be selected between 0ms and 350ms.

4.2.1.15 Clear Wake

The Clear Wake Button resets the WAKE pin manually.

4.2.1.16 Symbol Rate

The symbol rate can be adjusted between 512 symbols/s and 4096 symbols/s. The symbol rate defines the duration of one bit via the 32.768 kHz clock in order to recover the data.

4.2.1.17 Artificial Wake-up

The artificial wake-up automatically puts the chip into data receiving mode. This can be useful to measure the surrounding noise and adjust sensitivity settings accordingly. The period of the artificial wake-up can be adjusted between 1s and 2 hours.

4.2.1.18 Clear False Wake-up

The false wake-up register counts the number of frequency detections that do not match the wake-up pattern. The actual number of False Wake-ups can be deleted via the Clear False Wake-up button.

4.2.1.19 Reset RSSI

Reset the current RSSI measurement and restarts the AGC.

4.3 Description of the GUI for the Wake-up Transmitter Board

All adjustments that are made to the settings can be saved via “**Store Settings**” in the lower right corner of the ‘Transmitter’ tab. The settings can be reset to the default configuration by pushing the button “**Restore Default Settings**”.

Note: A possible Firmware Update can be done via Help/Firmware Update (Ctrl+F). Load the latest *.bin file for the transmitter and update the firmware.

Figure 9: Graphical User Interface (GUI) for the 125 kHz Wake-up Transmitter Board

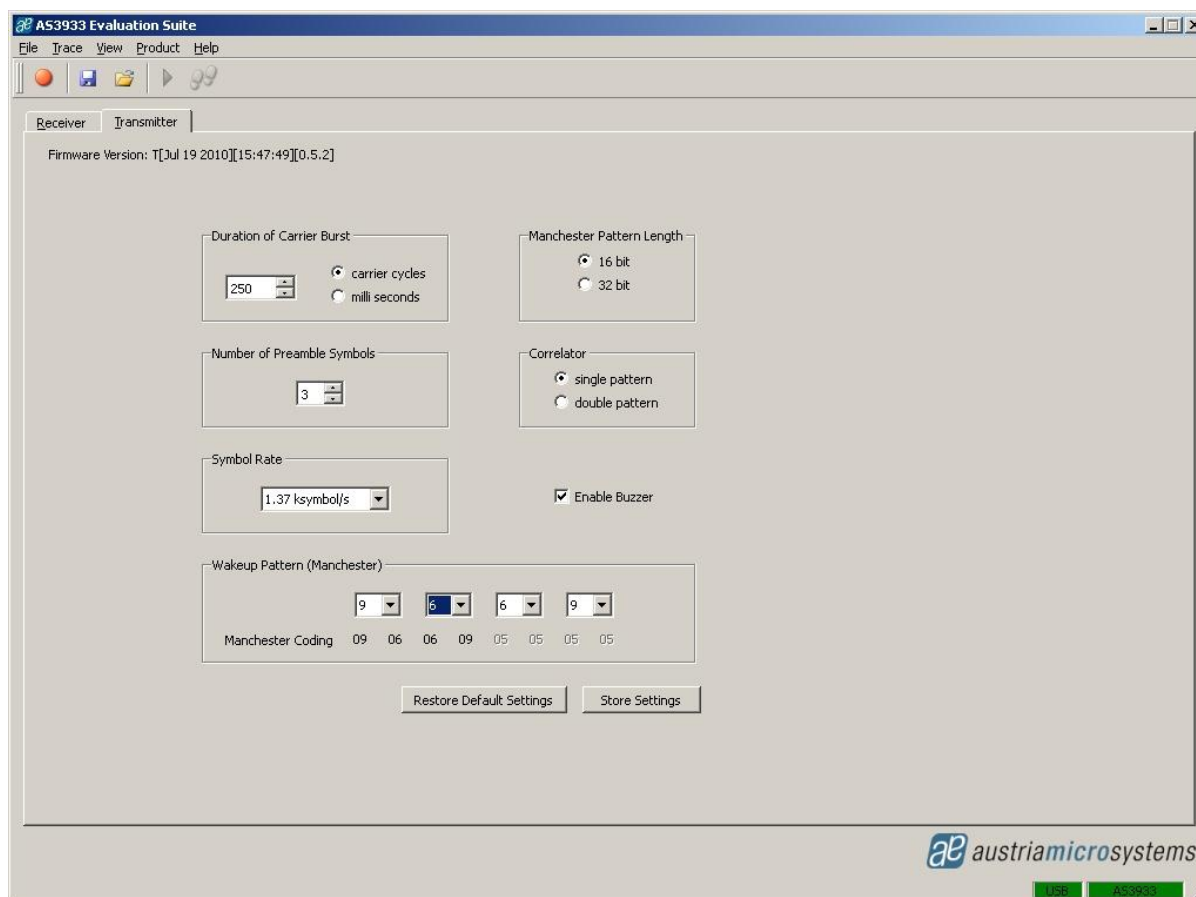

4.3.1 Settings Description

4.3.1.1 Duration of Carrier Burst

The duration of the carrier burst can be set in multiples of carrier cycles (0-500 x 8 μ s) or in milliseconds (1-3).

4.3.1.2 Number of Preamble Symbols

The carrier burst must be followed by a separation bit and at least 3 symbols preamble. The number of preamble symbols that are sent can be adjusted here.

4.3.1.3 Symbol Rate

The symbol rate can be adjusted between 512 symbols/s and 4096 symbols/s. The symbol rate must be the same as the symbol rate set for the AS3932.

4.3.1.4 Enable Buzzer

The Wake-up Transmitter Board sends out an acoustic signal whenever a packet is transmitted. This signal can be disabled.

4.3.1.5 Wake-up Pattern (Manchester)

The wake-up pattern of the transmitter must be the same as the pattern defined for the receiver in order to generate a successful wake-up at the receiver.

4.3.1.6 Manchester Pattern Length

This setting must also be the same as defined for the receiver to generate a successful wake-up.

4.3.1.7 Correlator

This setting must also be the same as defined for the receiver to generate a successful wake-up.

5 Schematics, Layers and BOM

5.1 AS3932 Demo Board Schematics

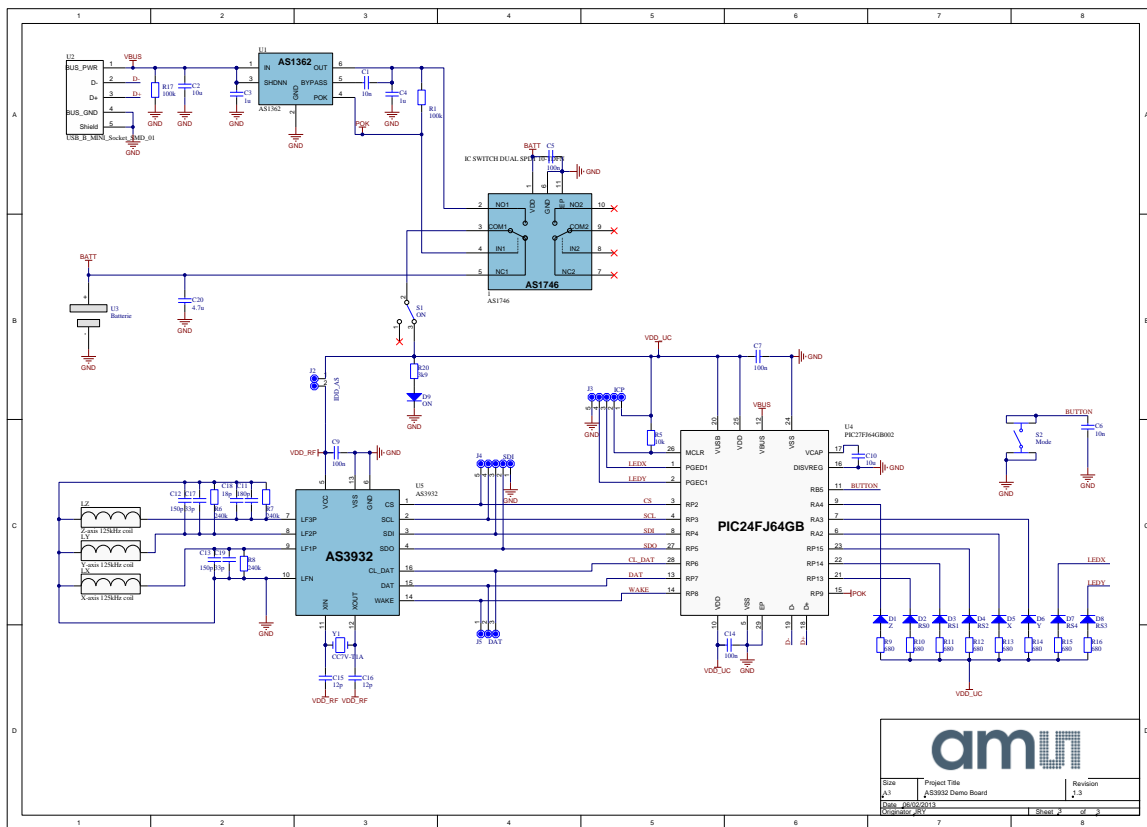

5.2 AS3932 Demo Board Layout

Figure 10: AS3932 Demo Board Layout – Top Layer

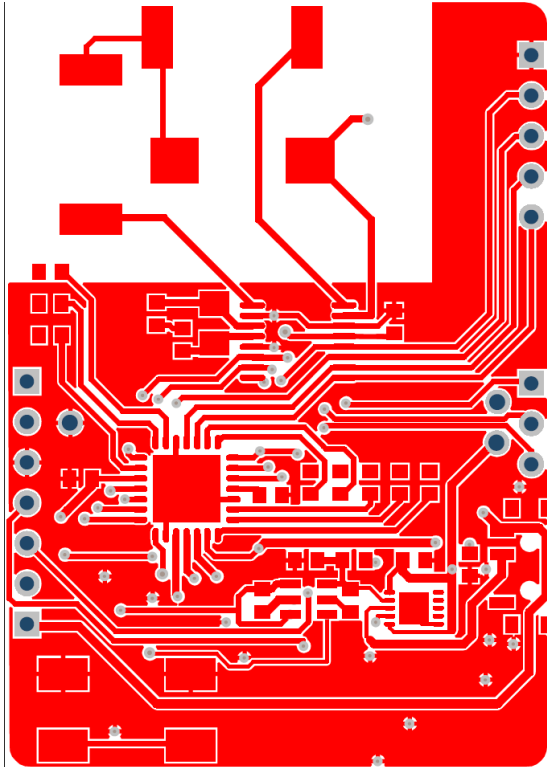
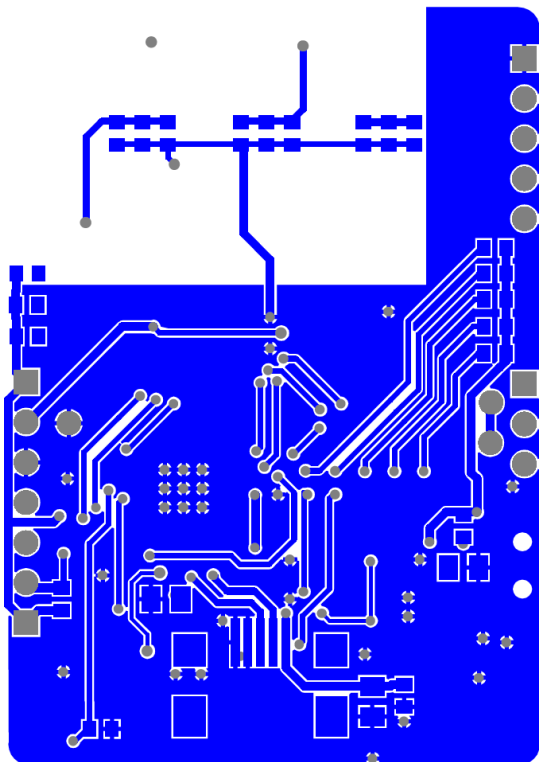

Figure 11: AS3932 Demo Board Layout – Bottom Layer



5.3 AS3932 Demo Board BOM

Bill of Materials			AS3932 Demo Board			
Company:			ams AG			
Originator:			JRY			
PCB Name:			AS3932 Demo Board			
PCB Version:			1.3			
Report Date:			06/02/2013			
#	Designator	Comment	Component Description	Manufacturer	Manufacturer Part Number	Quantity
1	1	AS1746	IC SWITCH DUAL SPDT 10-	ams	AS1746-BTDT	1
2	C1, C6	10n	C0603/10V/X5R			2
3	C2, C10	10u	C0805/6.3V/X5R			2
4	C3, C4	1u	Multilayer Ceramic	Yageo	CC0603KRX5R6BB105	2
5	C5, C7, C9, C14	100n	C0603/10V/X5R			4
6	C11	180p	Multilayer Ceramic	Murata	GRM1885C1H181GA01D	1
7	C12, C13	150p	Multilayer Ceramic	Murata	GRM1885C1H151GA01D	2
8	C15, C16	12p	TDK -	TDK	C1608C0G1H120J080AA	2
9	C17, C19	33p	Multilayer Ceramic	Murata	GRM1885C2A330GA01D	2
10	C18	18p	Multilayer Ceramic	Murata	GRM1885C1H180GA01D	1
11	C20	4.7u	C0805/6.3V/X5R			1
12	D1	Z	MULTICOMP - OVS-0608 -	MULTICOMP	OVS-0608	1
13	D2	RS0	MULTICOMP - OVS-0608 -	MULTICOMP	OVS-0608	1
14	D3	RS1	MULTICOMP - OVS-0608 -	MULTICOMP	OVS-0608	1
15	D4	RS2	MULTICOMP - OVS-0608 -	MULTICOMP	OVS-0608	1
16	D5	X	MULTICOMP - OVS-0608 -	MULTICOMP	OVS-0608	1
17	D6	Y	MULTICOMP - OVS-0608 -	MULTICOMP	OVS-0608	1
18	D7	RS4	MULTICOMP - OVS-0608 -	MULTICOMP	OVS-0608	1
19	D8	RS3	MULTICOMP - OVS-0608 -	MULTICOMP	OVS-0608	1
20	D9	ON	MULTICOMP - OVS-0608 -	MULTICOMP	OVS-0608	1
21	J2	IDD_AS	2 pole pin header			1
22	J3	ICP	not assembled			1
23	J4	SDI	5 pole pin header			1
24	J5	DAT	3 pole pin header			1
25	LX	X-axis 125kHz coil	7.2mH +/- 5%@ 125kHz	Premo	SDTR1103-0720J	1
26	LY	Y-axis 125kHz coil	7.2mH +/- 5%@ 125kHz	Premo	SDTR1103-0720J	1
27	LZ	Z-axis 125kHz coil	7.2mH +/- 5%@ 125kHz	Premo	ZC1003-0720J	1
28	R1, R17	100k	R0603/5%/0.1W			2
29	R5	10k	R0603/5%/0.1W			1
30	R6, R7, R8	240k	R0603/5%/0.1W			3
31	R9, R10, R11, R12, R13, R14,	680	R0603/5%/0.1W			8
32	R20	3k9	R0603/5%/0.1W			1
33	S1	ON	C & K COMPONENTS -	C & K COMPONENTS	PCM12SMTR	1
34	S2	Mode	TE CONNECTIVITY /	TE CONNECTIVITY /	FSM2JSMA	1
35	U1	AS1362	IC REG LDO 3V 3A TSOT23	ams	AS1362-BTTT-30	1
36	U2	USB_B_MINI_Socket_SMD_01	CONN RECEPT MINI USB2.0	Hirose Electric Co Ltd	UX60A-MB-S5T	1
37	U3	Batterie	RENATA - HU2032-LF -	RENATA	HU2032-LF	1
38	U4	PIC27FJ64GB002	MICROCHIP -	MICROCHIP	PIC24FJ64GB002-VMIL	1
39	U5	AS3932	IC RF PROGRAM 16-TSSOP	ams	AS3932-BTST	1
40	Y1	CCTV-T1A	MICRO CRYSTAL - CC7V-	MICRO CRYSTAL	CCTV-T1A 32.768KHZ +/-20PPM 9PF	1
Approved			Notes			59

5.4 125 kHz Wake-up Transmitter Board Schematics

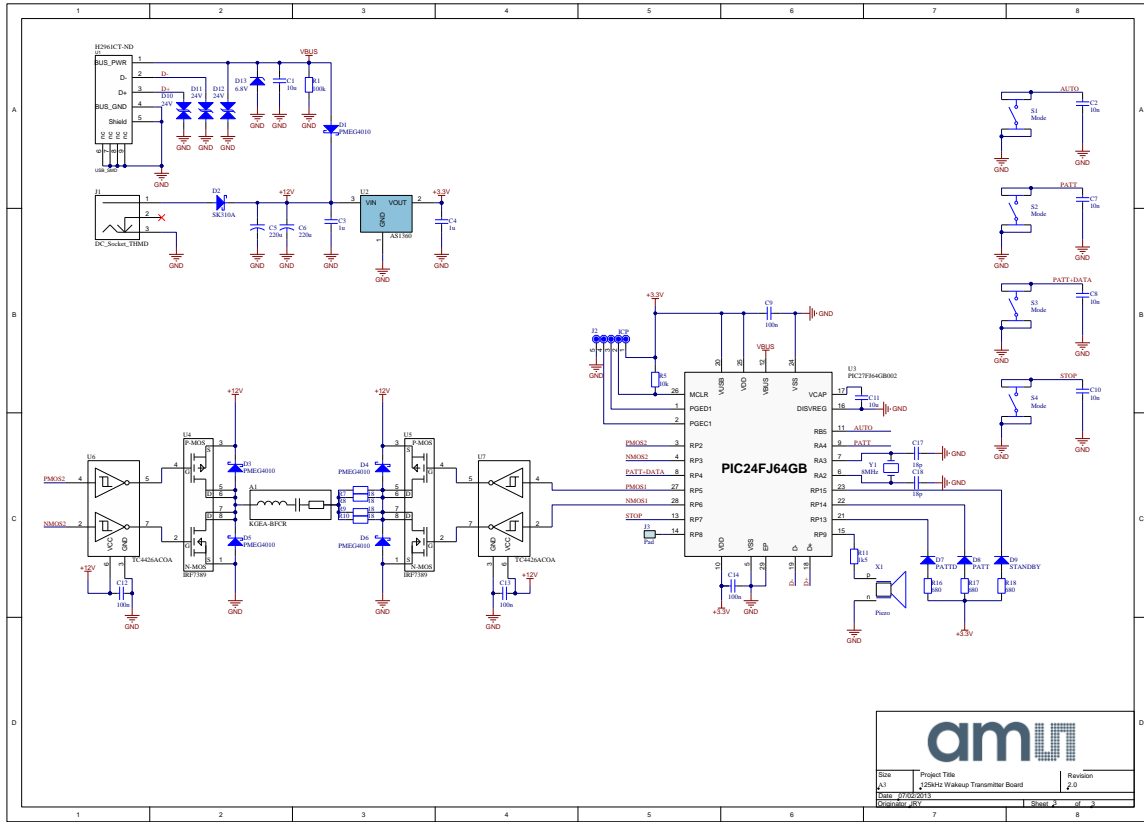

5.5 125 kHz Wake-up Transmitter Board Layout

Figure 12: 125 kHz Wake-up Transmitter Board Layout – Top Layer

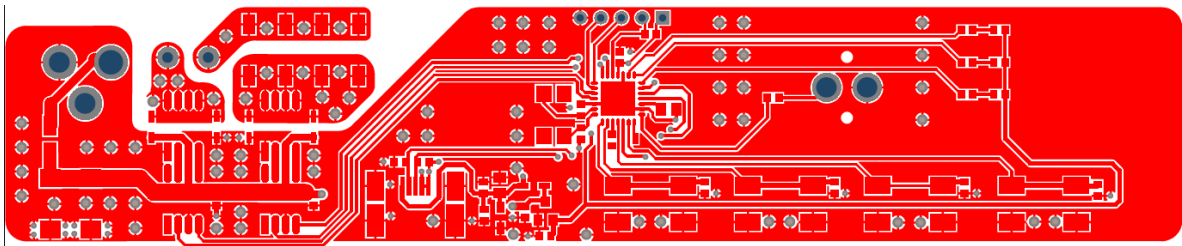
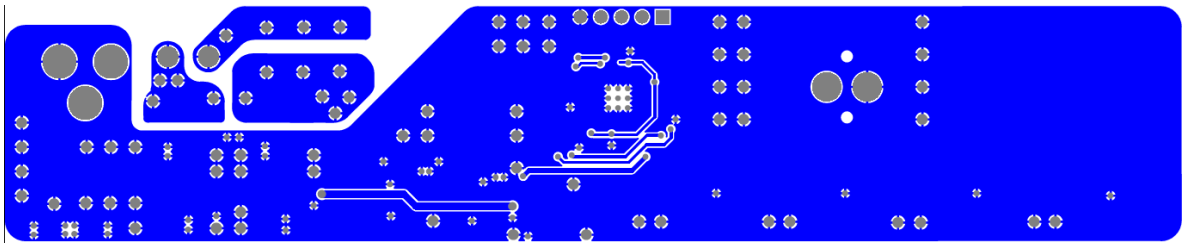

Figure 13: 125 kHz Wake-up Transmitter Board Layout – Bottom Layer



5.6 125 kHz Wake-up Transmitter Board BOM

Bill of Materials			125kHz Wakeup Transmitter Board			
Company:		ams AG				
Originator:		JRY				
PCB Name:		125kHz Wakeup Transmitter Board				
PCB Version:		2.0				
Report Date:		07/02/2013				
#	Designator	Comment	Component Description	Manufacturer	Manufacturer Part Number	Quantity
1	A1	KGEA-BFCR	LF Antenna/KGEA-BFCR-B-			1
2	C1, C11	10u	C0805/16V/X5R			2
3	C2, C7, C8, C10	10n	C0603/10V/X5R			4
4	C3, C4	1u	MULTICOMP -	MULTICOMP	MC0603X105M160CT	2
5	C5, C6	220u	KEMET - T491D227K016ZT -	KEMET	T491D227K016ZT	2
6	C9, C12, C13, C14	100n	C0603/10V/X5R			4
7	C17, C18	18p	C0603/50V/X5R			2
8	D1, D3, D4, D5, D6	PMEG4010	NXP - PMEG4010CEJ,115 -	NXP	PMEG4010CEJ,115	5
9	D2	SK310A	TAIWAN SEMICONDUCTOR -	TAIWAN SEMICONDUCTOR	SK310A	1
10	D7	PATTD	MULTICOMP - OVS-0608 -	MULTICOMP	OVS-0608	1
11	D8	PATT	MULTICOMP - OVS-0608 -	MULTICOMP	OVS-0608	1
12	D9	STANDBY	MULTICOMP - OVS-0608 -	MULTICOMP	OVS-0608	1
13	D10, D11, D12	24V	COOPER BUSSMANN -	COOPER BUSSMANN	0603ESDA-TR1	3
14	D13	6.8V	ON SEMICONDUCTOR -	ON SEMICONDUCTOR	MM3Z6V8T1G	1
15	J1	DC_Socket_THMD	LUMBERG - NEB 21 R -	LUMBERG	NEB 21 R	1
16	J2	ICP	5 pole pin header/2.54mm			1
17	R1	100k	R0603/5%/0.1W			1
18	R5	10k	R0603/5%/0.1W			1
19	R7, R8, R9, R10	18	TE CONNECTIVITY / CGS -	TE CONNECTIVITY / CGS	SMW218RJT	4
20	R11	1k5	R0603/5%/0.1W			1
21	R16, R17, R18	680	VISHAY DRALORIC -	VISHAY DRALORIC	CRCW0603680RFKEAHP	3
22	S1, S2, S3, S4	Mode	TE CONNECTIVITY /	TE CONNECTIVITY /	FSM2J5MA	4
23	U1	USB_SMD	CONN RECEPT USB SPOS	Molex Connector	56579-0576	1
24	U2	AS1360	IC REG LDO 3.3V .15A	ams	AS1360-33-T	1
25	U3	PIC27FJ64GB002	MICROCHIP -	MICROCHIP	PIC24FJ64GB002-IML	1
26	U4, U5	IRF7389	INTERNATIONAL RECTIFIER	INTERNATIONAL RECTIFIER	IRF7389TRPBF	2
27	U6, U7	MC33151	ON SEMICONDUCTOR -	ON SEMICONDUCTOR	MC33151DG	2
28	X1	Piezo	MURATA -	MURATA	PKM13EPYH4002-B0	1
29	Y1	8MHz	ABRACON - ABMM2-	ABRACON	ABMM2-8.000MHZ-E2-T	1
Approved			Notes			55

6 Ordering & Contact Information

Ordering Code	Description
AS3932 DEMOBOARD	AS3932 Demo Kit Standard Board

Buy our products or get free samples online at:

www.ams.com/ICdirect

Technical Support is available at:

www.ams.com/Technical-Support

Provide feedback about this document at:

www.ams.com/Document-Feedback

For further information and requests, e-mail us at:

ams_sales@ams.com

For sales offices, distributors and representatives, please visit:

www.ams.com/contact

Headquarters

ams AG

Tobelbaderstrasse 30

8141 Unterpemstaetten

Austria, Europe

Tel: +43 (0) 3136 500 0

Website: www.ams.com

7 Copyrights & Disclaimer

Copyright ams AG, Tobelbader Strasse 30, 8141 Unterpremstaetten, Austria-Europe. Trademarks Registered. All rights reserved. The material herein may not be reproduced, adapted, merged, translated, stored, or used without the prior written consent of the copyright owner.

Demo Kits, Evaluation Kits and Reference Designs are provided to recipient on an “as is” basis for demonstration and evaluation purposes only and are not considered to be finished end-products intended and fit for general consumer use, commercial applications and applications with special requirements such as but not limited to medical equipment or automotive applications. Demo Kits, Evaluation Kits and Reference Designs have not been tested for compliance with electromagnetic compatibility (EMC) standards and directives, unless otherwise specified. Demo Kits, Evaluation Kits and Reference Designs shall be used by qualified personnel only.

ams AG reserves the right to change functionality and price of Demo Kits, Evaluation Kits and Reference Designs at any time and without notice.

Any express or implied warranties, including, but not limited to the implied warranties of merchantability and fitness for a particular purpose are disclaimed. Any claims and demands and any direct, indirect, incidental, special, exemplary or consequential damages arising from the inadequacy of the provided Demo Kits, Evaluation Kits and Reference Designs or incurred losses of any kind (e.g. loss of use, data or profits or business interruption however caused) as a consequence of their use are excluded.

ams AG shall not be liable to recipient or any third party for any damages, including but not limited to personal injury, property damage, loss of profits, loss of use, interruption of business or indirect, special, incidental or consequential damages, of any kind, in connection with or arising out of the furnishing, performance or use of the technical data herein. No obligation or liability to recipient or any third party shall arise or flow out of ams AG rendering of technical or other services.